



Hey kids,  
make sure to ask an  
adult for help!



# ASTRID PAPER TOY

## ASSEMBLY INSTRUCTIONS

- 1 Score all the pieces, using a ruler as a guide and running the backside of a butter knife firmly along all dotted lines.
- 2 Using scissors or a craft knife and cutting mat, cut out all pieces along solid lines.



- 3 Fold all pieces along score lines, using the folding key below as a reference.

Mountain Fold



Valley Fold



### GETTING STARTED

- Materials:
- Metal-edged ruler
  - Butter knife
  - Scissors or craft knife
  - Cutting mat (optional)
  - Multipurpose glue

### ASSEMBLE ASTRID

- 4 Body: Poke holes in the X slits. Insert a pencil in each slit to make the holes wider.



- 5 Body: Glue tab A, forming a cone shape. Let dry.

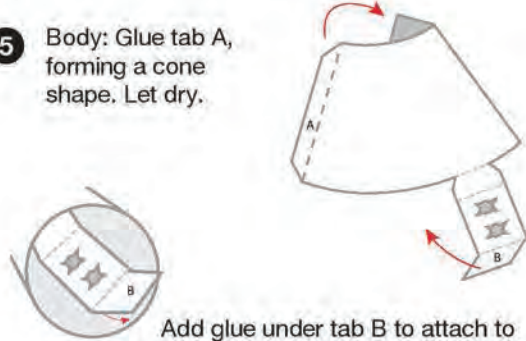

Add glue under tab B to attach to the inside of the cone. Hold until dry.

- 6 Arms & Cuffs: Fold in half and glue arm sides together. Then cut along solid lines and fold tabs

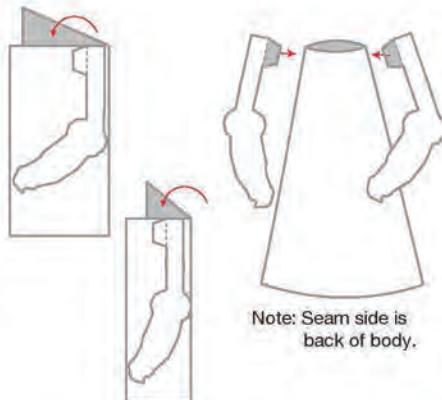

Note: Seam side is back of body.

- 7 Armor: Add glue to wedge areas and fasten edge to create cone shapes. Let dry.

After glue is dry, glue the middle of armor to the front of the body on the indicated mark.

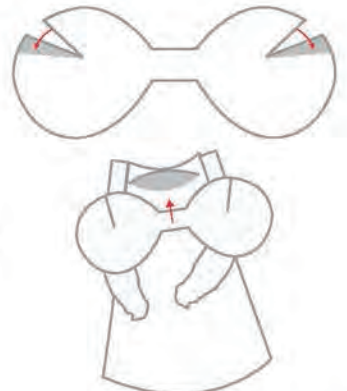

8

Head: Starting with the back of the head, glue A tabs on the left side, let dry. Repeat on right side with B tabs, let dry. Glue the neck closed by securing C tabs.

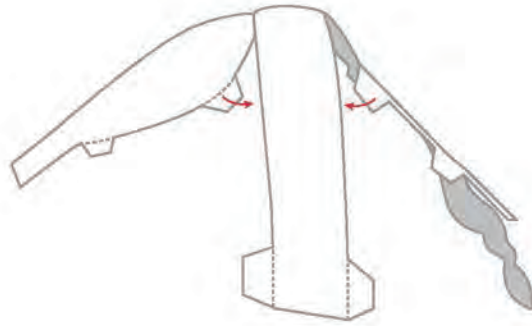

9

Hood: Add glue to wedge areas and fasten edge to create a cone shape.

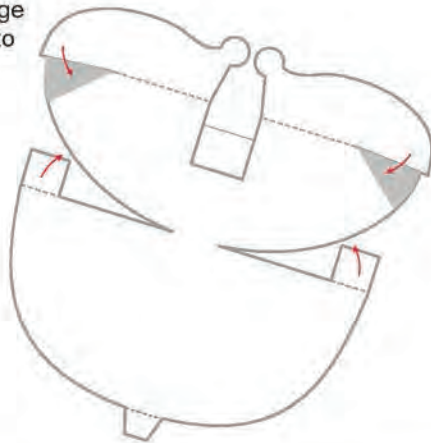

10

HOOD: After glue is dry, glue A tab to the back of the neck, Matching the bottom of the tab with the bottom of the neck.

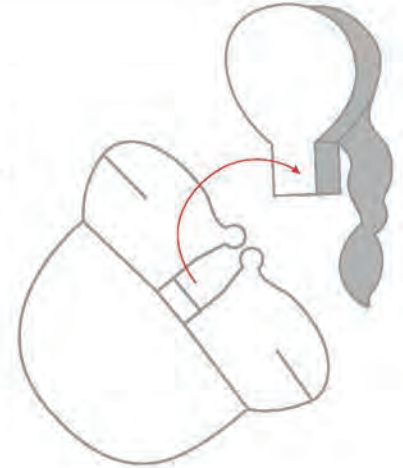

11

Head and Body: Glue front of neck to the front of the body.

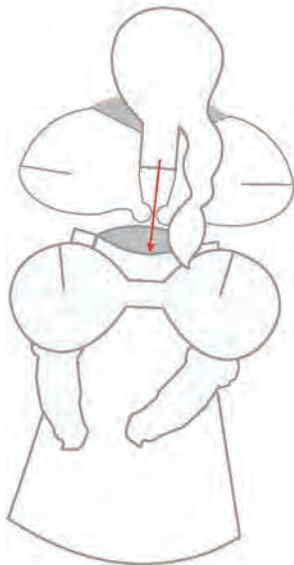

12

Head and Body: Glue hood skulls to the front of armor. Glue B tab on the back of the hood to to the back of the dress.

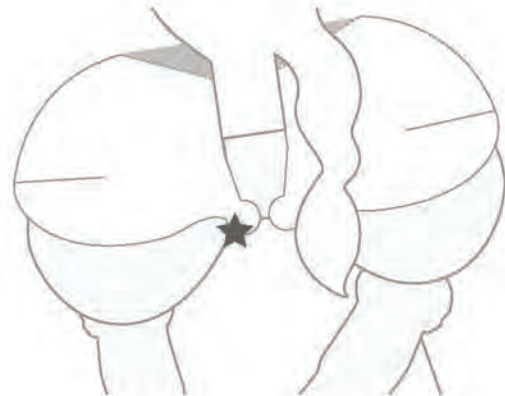

12

Legs: Using a pencil, roll leg piece to form a tight cylinder. Glue and hold until dry. Remove pencil.

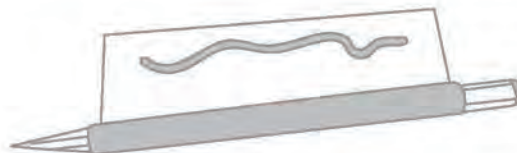

**TIP:**  
Add glue just before edge.

13

Boots: Glue A tabs to side panel. Close back of boot by folding side panel over B tabs. Glue to secure.

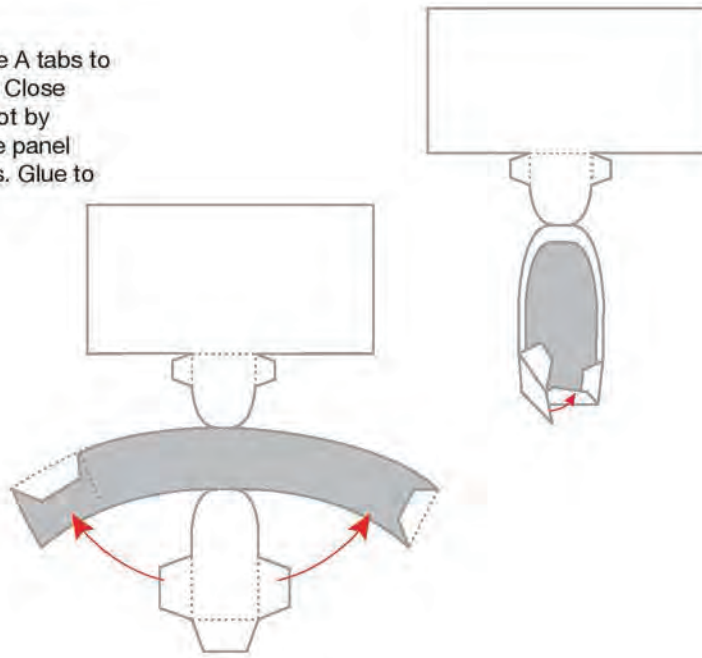

14

Boots: Glue C tab of the cuff to the inside of the top part of the boot, artwork facing out.

Turn boot to face you. Glue D tabs to inside of side panel. Bend top of boot at score line towards the front of the boot.

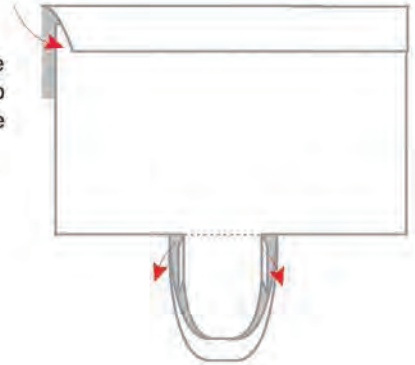

15

Boots: Turn boot away from you. Curl and glue top of boot to E tab, starting with left side, then right side, creating a cylinder.



When boots are dry, place them onto leg ends and glue to secure. Once boots are properly fastened, insert legs into body. Glue in place

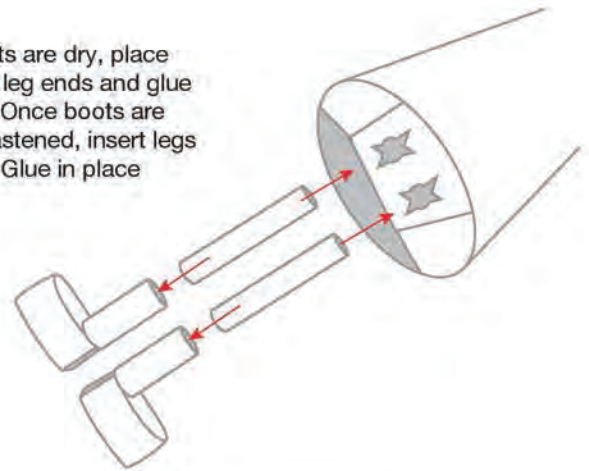

16

Axe: Fold Axe in half, glue together and let dry.

Cut along solid lines and glue Axe to inside of left hand.

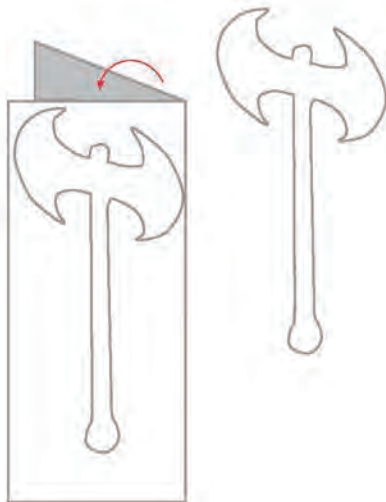

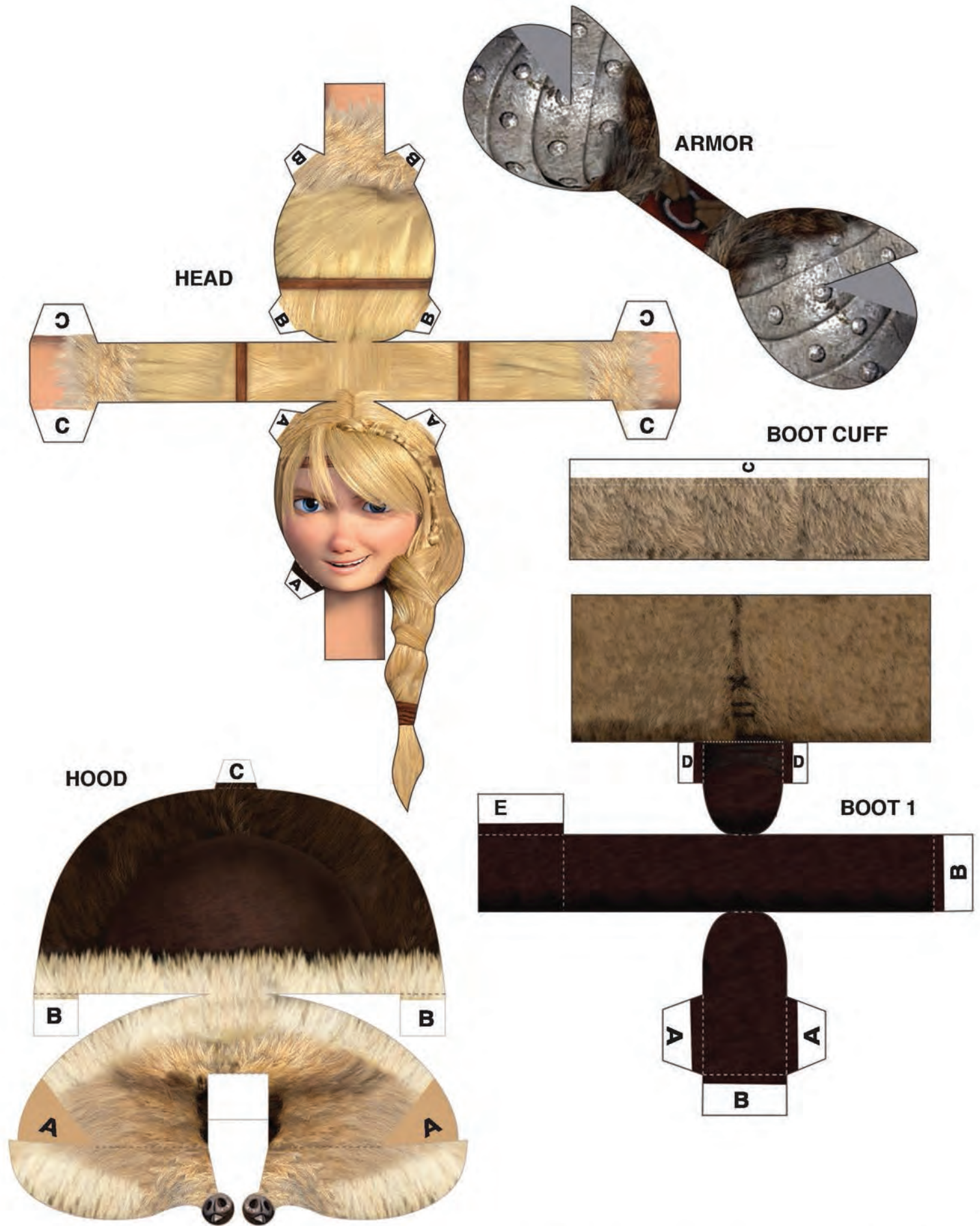

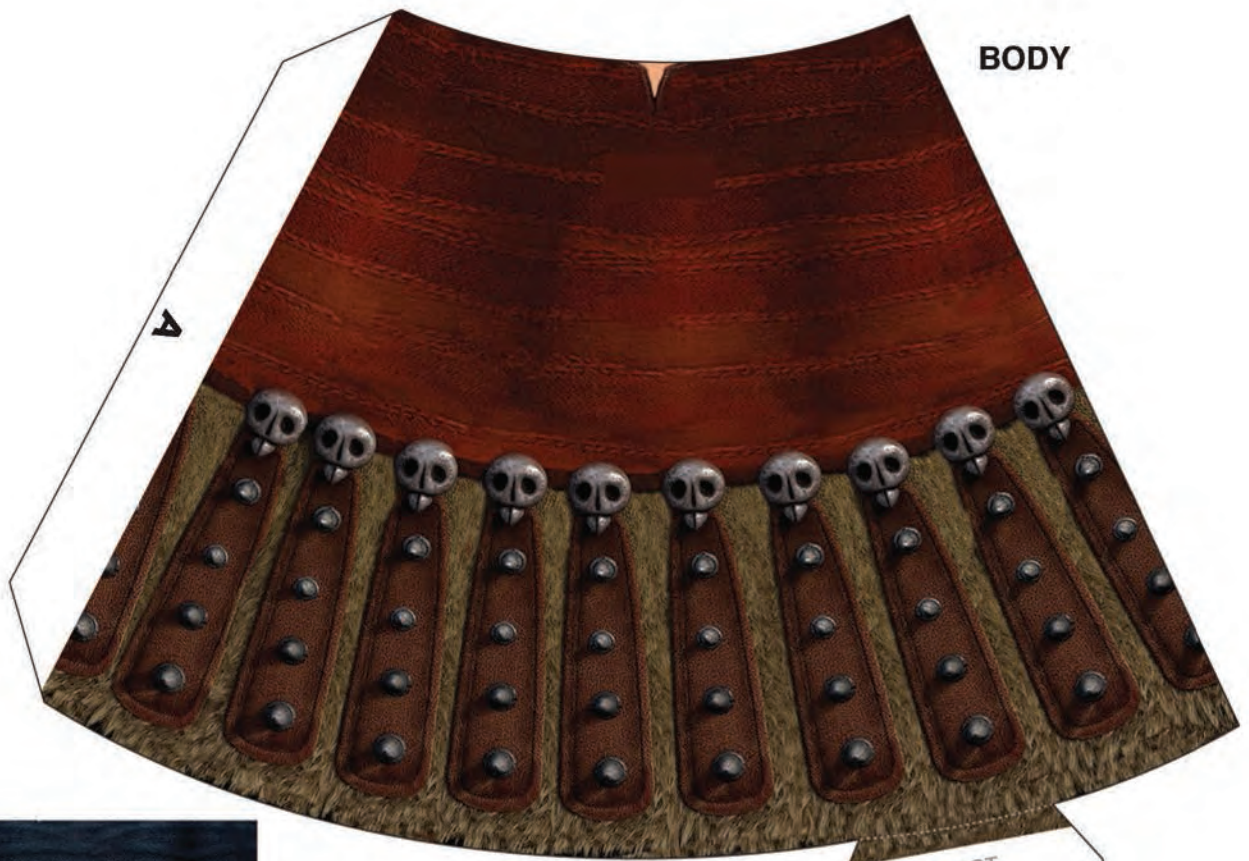

**BODY**

**A**



**LEG 2**

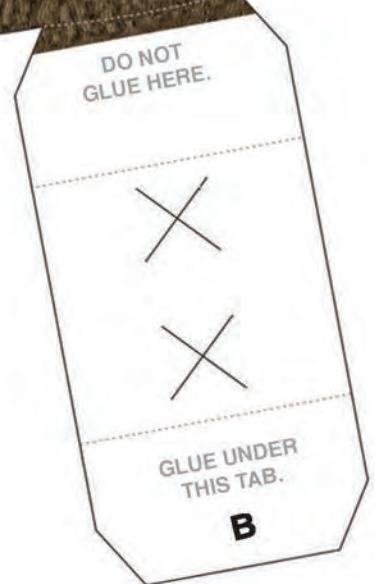

**BOOT 2**



**BOOT CUFF**

**C**

